



# TrailBlazer™ Series

Backpack Vacuums

by ProTeam™

**Model No.:**

**613017 - TrailBlazer™ includes EZ Glide™ Kit**

**613018 - TrailBlazer™ Lite includes EZ Glide™ Kit**

**613019 - TrailBlazer™ XL includes EZ Glide™ Kit**

**Operator and Parts Manual**



**NOBLES**  
12875 RANSOM STREET  
HOLLAND MI 49424 U.S.A.

**CUSTOMER SERVICE: 1-800-365-6625**  
**FAX: 1-800-678-4240**

**612909**  
**Rev. 00 (11-01)**

# OPERATION

---

Carefully unpack and inspect your new vacuum for shipping damage. Each unit is tested and thoroughly inspected before shipping. For instructions regarding any shipping damage, contact Nobles immediately. All returns must have a Return Authorization Number (RAN).

This manual is furnished with each new unit. It provides necessary operation and maintenance instructions and an illustrated parts list.

**Read this manual completely and understand the machine before operating or servicing it.**

Use the Parts Lists to order parts. Before ordering parts or supplies, be sure to have your machine model number and serial number handy. Parts and supplies may be ordered by phone or mail from any authorized parts and service center, distributor or from any of the manufacturer's subsidiaries.

This machine will provide excellent service. However, the best results will be obtained at minimum costs if:

- The machine is operated with reasonable care.
- The machine is maintained regularly - per the machine care instructions provided.
- The machine is maintained with manufacturer supplied or equivalent parts.

This machine is intended for commercial use only. It is suited to pick up dirt, dry debris and dust in an indoor environment and is not constructed for any other use. The pick up of any type of fluid or dangerous dust is prohibited. Use only recommended accessories.

---

## MACHINE DATA

---

Please fill out at time of installation for future reference.

Model No.- \_\_\_\_\_

Install. Date - \_\_\_\_\_

Serial No.- \_\_\_\_\_

© 2001 Tennant Company

Printed in U.S.A.

Nobles is a registered United States trademark of Tennant Company.

TrailBlazer is a United States trademark of Tennant Company.

**TABLE OF CONTENTS**

<b>SAFETY INSTRUCTIONS</b> .....	<b>4</b>	<b>FILTER MAINTENANCE</b> .....	<b>11</b>
GROUNDING INSTRUCTIONS .....	5	TRAILBLAZER™ AND TRAILBLAZER™ LITE	11
<b>PREPARING THE VACUUM FOR OPERATION</b>	<b>5</b>	TRAILBLAZER™ XL .....	12
TRAILBLAZER™ .....	5	<b>RECOMMENDED STOCK ITEMS</b> .....	<b>13</b>
TRAILBLAZER™ LITE .....	6	<b>SPECIFICATIONS</b> .....	<b>13</b>
TRAILBLAZER™ XL .....	8	<b>PARTS LIST</b> .....	<b>14</b>
<b>ELECTRICAL CORD CARE</b> .....	<b>9</b>	TRAILBLAZER™ .....	14
<b>PROPER STORAGE</b> .....	<b>10</b>	TRAILBLAZER™ LITE .....	16
<b>PROPER VACUUMING MOTION FOR LARGE</b>		TRAILBLAZER™ XL .....	18
<b>AREAS WITH DIRECT SUCTION TOOLS</b> .....	<b>10</b>	<b>OPTIONS</b> .....	<b>20</b>
<b>ERGONOMICS</b> .....	<b>10</b>	RESTAURANT VAC TOOL KIT .....	20
<b>CARING FOR YOUR VACUUM</b> .....	<b>10</b>	COMMERCIAL VAC TOOL KIT .....	20
<b>PREVENTATIVE MAINTENANCE</b> .....	<b>10</b>	E-Z GLIDE™ COMMERCIAL VAC TOOL KIT	20
<b>TROUBLESHOOTING</b> .....	<b>11</b>	TURBO FLOOR TOOL .....	21
		JETSWEEP™ FLOOR TOOL .....	21

## OPERATION

---

### SAFETY INSTRUCTIONS

---

**⚠ WARNING:** To reduce the risk of fire, electric shock or injury, read the following:

1. Do not vacuum with a frayed, worn, or damaged cord.
2. Do not vacuum liquids or expose the backpack vacuum to rain or water.
3. Do not vacuum hazardous or toxic materials.
4. Do not use to pick up flammable or hazardous materials.
5. Do not leave the unit plugged in when it is not in use. Unplug it from the outlet when the unit is not in use and before servicing.
6. Do not use outdoors or on wet surfaces.
7. Do not try to recover any liquid with this vacuum. This vacuum is for DRY RECOVERY only.
8. Use only as described in this manual. Use only manufacturer's recommended attachments and replacement parts.
9. To prevent electrical damage, use the recommended 50 foot/16 gauge extension cord provided. If you need to use a 100 foot cord, it must be 14 gauge or better. DO NOT use cords longer than 100 feet.
10. Do not use a damaged cord or plug. If the unit is not working as it should, or if it has been dropped, damaged, left outdoors, or exposed to water, return it to an authorized servicing dealer for inspection.
11. Do not pull or carry the vacuum by the cord or use the cord as a handle. Do not close a door on the cord or pull the cord around sharp edges or corners. Do not run over the cord. Keep the cord away from heated surfaces.
12. Do not pull on the cord to unplug. Grasp the plug at the outlet and pull.
13. Do not handle the plug or vacuum with wet hands.
14. Do not put any objects into openings. Keep hair, loose clothing, fingers, and all parts of the body away from openings and moving parts. Long hair should not hang over or near the unit.
15. Do not vacuum flammable or combustible materials or anything that is burning or smoking, such as cigarettes, matches, or hot ashes.
16. Empty the filter bag after every use and before storage. Some types of dust and debris may combust.
17. Turn off the unit before unplugging.
18. Connect commercial-rated units to properly grounded outlets only.
19. Use with care when cleaning stairs.
20. Do not allow to be used as a toy. Close attention is necessary when used by or near children.

**SAVE THESE INSTRUCTIONS - Violation of any of these instructions may void any and all warranties.**

## GROUNDING INSTRUCTIONS

The vacuum Must be grounded. If the vacuum should malfunction or stop working, grounding provides a path of least resistance for electrical current, thereby reducing the risk of electrical shock. This unit is equipped with a cord that has an equipment-grounding conductor and grounding plug. The plug must be inserted in an appropriate outlet that is properly installed and grounded in accordance with all local codes and ordinances. Cutting off the ground wire or using a cord that is not equipped with a ground plug will void the warranty on the unit, and Nobles will accept NO liability associated with the unit.

Improper connection of the equipment-grounding connector conductor can result in a risk of electrical shock. Check with a qualified electrician or service person if you doubt that the outlet is properly grounded. Do not modify the plug provided with the vacuum. If it will not fit the outlet, have a proper outlet installed by a qualified electrician.

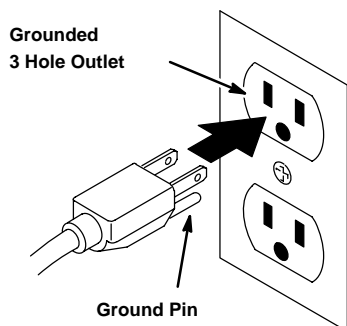

(120V)

## PREPARING THE VACUUM FOR OPERATION

### TRAILBLAZER™ MODEL

1. Remove the top cap and pull out the cloth filter. Check to see that the dome filter has not shifted during shipping (Figure 1).

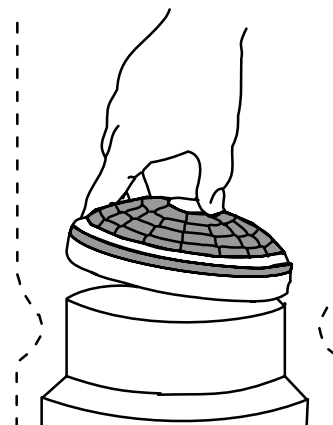

FIG. 1

2. Install a Micro filter inside of the cloth filter. At the beginning of each shift, the filters should be checked. Empty or replace as necessary.

**NOTE:** Never use a Micro filter without the cloth filter.

3. Replace the cap. Push the hose into the cap opening (Figure 2).

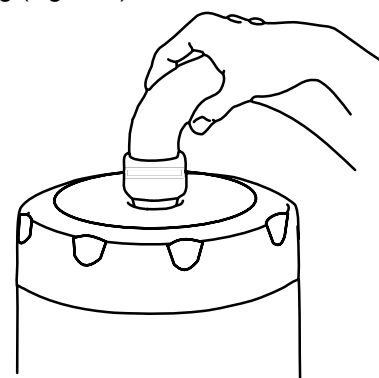

FIG. 2

# OPERATION

4. Twist the aluminum wand into the hose. Check hose cuffs at both ends to make sure that they are tight.
5. Loosen the shoulder straps and waist belt. In an open area, lift the vacuum by one shoulder strap and slide your free arm into the other strap (Figure 3).



FIG. 3

6. Fasten the waist belt snugly and make sure the weight is resting comfortably on your hips (Figure 4).

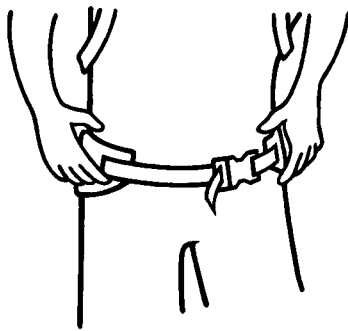

FIG. 4

**NOTE:** The backplate is adjustable up or down by removing the four screws that attach to the vacuum's body.

7. Check the wear on the cord by the vacuum body and at the plug. Place the extension cord between the waist belt's strap and padded area to signal you if you have run out of cord while vacuuming (Figure 5).

**⚠ WARNING:** To reduce the risk of fire, electric shock or injury, do not pull or carry the vacuum by the cord or use the cord as a handle. Do not close door on cord or pull the cord around sharp edges or corners. Do not run over the cord. Keep the cord away from heated surfaces. Do not pull on the cord to unplug. Grasp the plug at the outlet and pull. Work within cord length to avoid stress and damage.

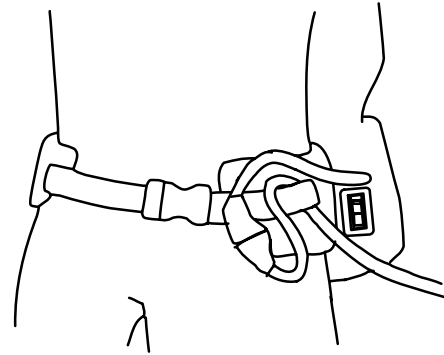

FIG. 5

8. To attach tools to an aluminum wand, LOOSEN the plastic nut at the end of the wand, insert the tool, and retighten the nut. To ensure the copper ring stays in place, NEVER remove the nut.

## TRAILBLAZER™ LITE MODEL

1. Remove the cap and pull out the cloth filter. Check to see that the dome filter has not shifted during shipping (Figure 6).

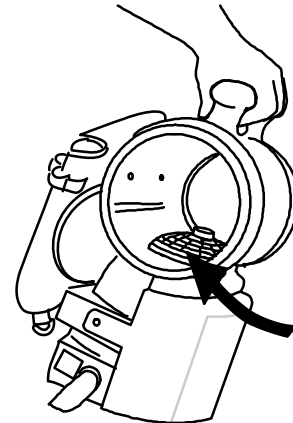

FIG. 6

2. Install a Micro filter inside of the cloth filter. At the beginning of each shift, the filters should be checked. Empty or replace them if necessary.

**NOTE:** Never use a Micro filter without the cloth filter. The cloth filter's rubber gasket provides the seal.

3. Replace the cap. Push the hose into the end cap opening (Figure 7). End caps are interchangeable for right- or left-handed operators.

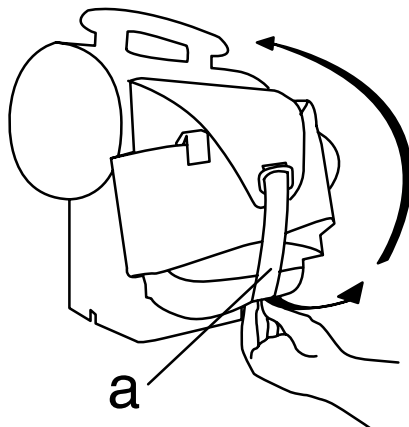

**FIG. 7**

4. The new waistbelt with monostrap system allows the Trailblazer Lite to be utilized in three different ways to accommodate the user with a choice of comfortable adjustments.

With the waist belt wrapped up in an envelope-style packet, the vacuum can be carried by the molded top handle or, with the monostrap connected, can be slung over the shoulder. The vacuum can also be worn around the waist with or without the monostrap for support.

5. Detach the Velcro® strap (a) from the base of the waistbelt and lift the strap (Figure 8).



**FIG. 8**

6. Slide the Velcro® strap (a) under the molded plastic handle of the vacuum and back around over the top of the handle. Attach the end of the strap to the Velcro® tab (Figure 9).

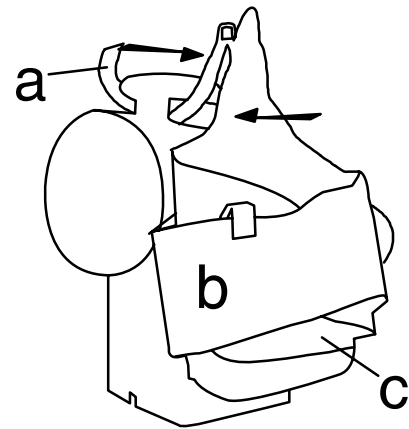

**FIG. 9**

7. With the waistbelt facing you, use your right hand to separate the exposed Velcro® between the end of the flap and the back of the belt (Figure 10).

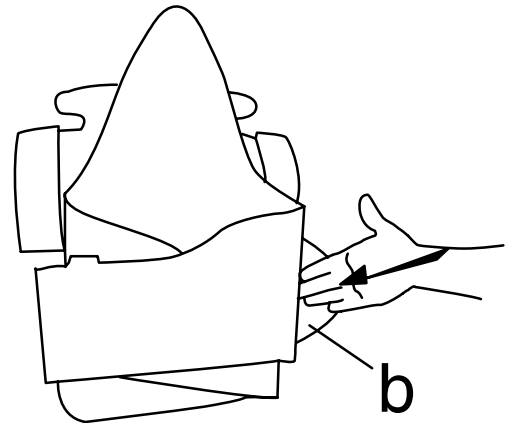

**FIG. 10**

8. Continue to slide your right hand all the way to the left to separate the remaining Velcro® (Figure 11). With your left hand, pull the flap (b) out from behind the waistbelt and toward you to expose flap c.

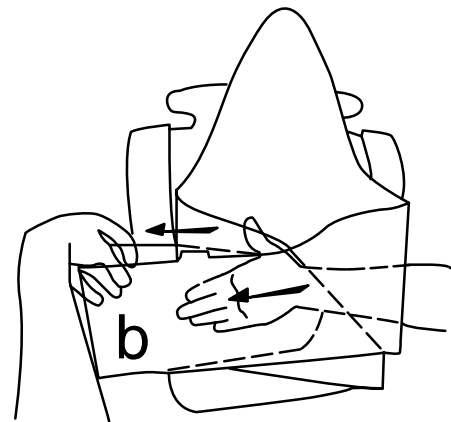

**FIG. 11**

## OPERATION

9. To put the vacuum on, slide the monostrap up over your preferred shoulder. Fasten the belt by bringing the right flap (C) across the front, then bring the left flap (B) over on top of it. (Figure 12).

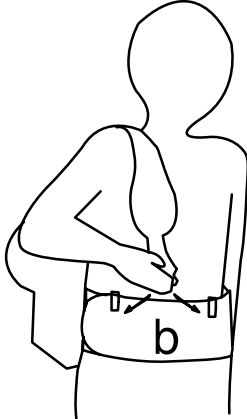

FIG. 12

10. Adjust the comfort of the shoulder strap by adjusting the length of the strap and/or attaching the front snap hook to any of the other rings on the front of the waistbelt (Figure 13).

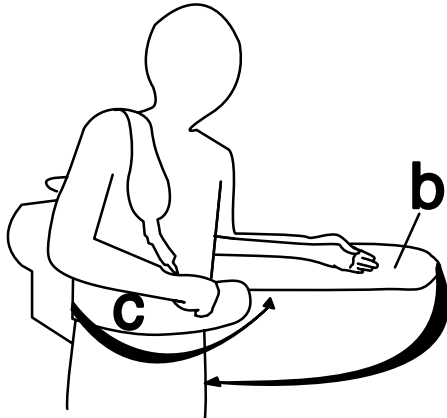

FIG. 13

**NOTE:** For maximum comfort, alternate the shoulder strap to the right or left shoulder every two hours.

**NOTE:** If monostrap is not attached, insert this step between steps 8 and 9. Attach the hook on the short end of the monostrap to the ring up on the end of the Velcro® strap (a). Attach the hook on the other end of the monostrap to any of the four rings on the waistbelt. Attach to rings on flap c if right-handed, and flap b if left-handed.

11. Twist the aluminum wand into the hose. Check hose cuffs at both ends to make sure that they are tight.

### TRAILBLAZER™ XL MODEL

1. Unlatch and remove the top cap and pull out the cloth filter. Check to see that the dome filter has not shifted during shipping (Figure 14).

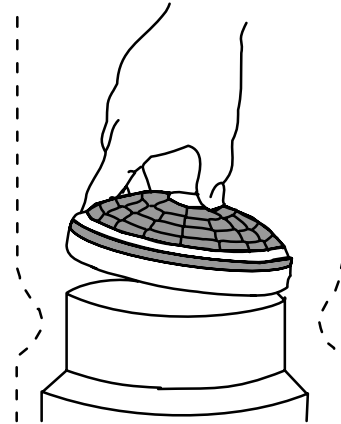

FIG. 14

2. Reinstall the cloth filter, making sure that the lip of the filter completely covers the rim of the vacuum (Figure 15).

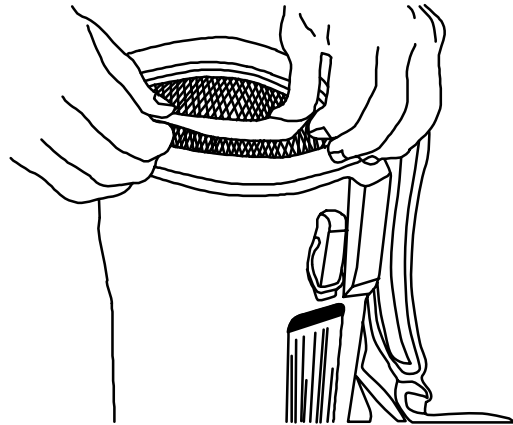

FIG. 15

3. Install a Micro filter (if there is not one already installed) by sliding the gasket of the Micro filter over the inlet on the inside of the top cap (Figure 16). Replace the cap, making sure that the latches catch correctly.



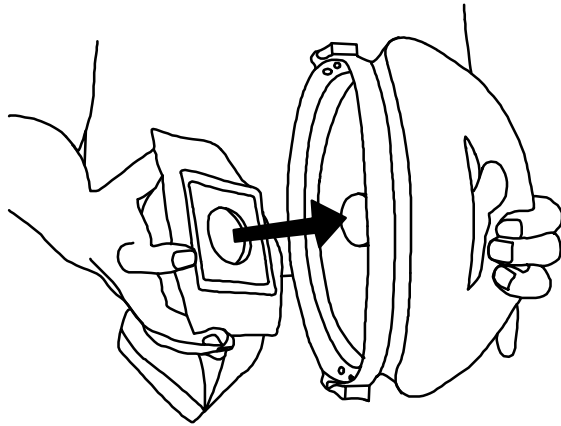

FIG. 16

At the beginning of each shift, the filters should be checked. Empty or replace as necessary.

**NOTE:** Never use a Micro filter without the cloth filter.

4. Push the hose into the cap opening .
5. Twist the aluminum wand into the hose. Check hose cuffs at both ends to make sure that they are tight.
6. Loosen the shoulder straps and waist belt. In an open area, lift the vacuum by one shoulder strap and slide your free arm into the other strap (Figure 17).

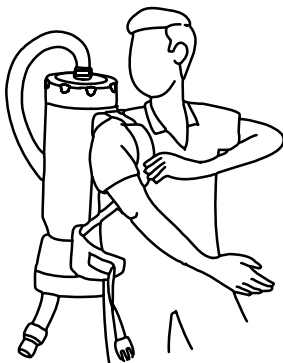

FIG. 17

7. Fasten the waist belt snugly and make sure the weight is resting comfortably on your hips (Figure 18).

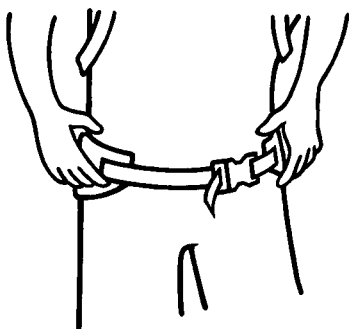

FIG. 18

**⚠ WARNING:** To reduce the risk of fire, electric shock or injury, do not pull or carry the vacuum by the cord or use the cord as a handle. Do not close door on cord or pull the cord around sharp edges or corners. Do not run over the cord. Keep the cord away from heated surfaces. Do not pull on the cord to unplug. Grasp the plug at the outlet and pull. Work within cord length to avoid stress and damage.

8. Check the wear on the cord by the vacuum body and at the plug. Place the extension cord between the waist belt's strap and padded area to signal you if you have run out of cord while vacuuming (Figure 19).

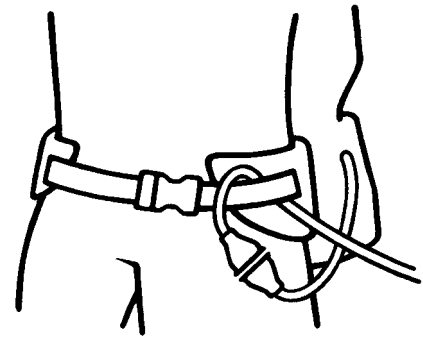

FIG. 19

9. To attach tools to a 1½" aluminum wand, LOOSEN the plastic nut at the end of the wand, insert the tool, and retighten the nut. To ensure the copper ring stays in place, NEVER remove the nut.

---

## ELECTRICAL CORD CARE

---

NEVER stretch the cord tightly between the vacuum and the outlet. A cord that is stretched or pulled will not function properly and creates a danger.

After vacuuming, unplug the cord (at both ends of an extension cord) and wind it up loosely. DO NOT wind the cord up by wrapping it around your hand and elbow.

**⚠ WARNING:** To reduce the risk of fire, electric shock or injury, do not pull on the cord to unplug. Grasp the plug at the outlet and pull. Work within cord length to avoid stress and damage. Do not handle the plug or vacuum with wet hands.

# OPERATION

---

---

## PROPER STORAGE

---

When the vacuum is not in use, it should be stored in a dry place.

**⚠ WARNING:** To reduce the risk of fire, electric shock or injury, empty the filter bag after every use and before storage. Some types of dust and debris may combust.

---

## PROPER VACUUMING MOTION FOR LARGE AREAS WITH DIRECT SUCTION TOOLS

---

1. Begin with the wand parallel to your body.
2. Draw the top of the wand in toward your waist and twist at the waist walking backward or forward (a side-to-side motion) (Figure 20).

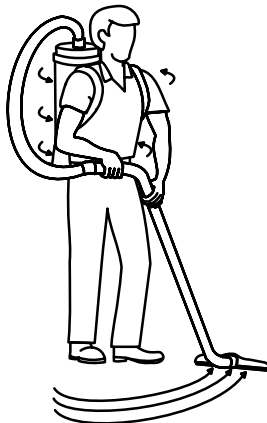

FIG. 20

3. The motion is similar to mopping and keeps the upper body and arms from tiring.

**⚠ WARNING:** DO NOT use machine to pick up flammable or combustible materials or anything that is burning or smoking, such as cigarettes, matches, or hot ashes.

---

## ERGONOMICS

---

- The weight of the vacuum should be carried on the operator's hips and be evenly distributed.
- The padded waist belt or waist and shoulder straps are adjustable for a custom fit.
- The backpack vacuums have a ventilated backplate to keep the operator cool.

- The on/off switch is conveniently placed for easy access on the waist belt of the TrailBlazer and on the left side of the Trailblazer Lite body.

Use the proper attachments for the job. Pro-Team has attachments to perform most jobs without requiring that the operator bend over or get into difficult positions.

---

## CARING FOR YOUR VACUUM

---

**⚠ WARNING:** To reduce the risk of fire, electric shock or injury unplug unit from wall outlet when not in use and before servicing.

1. Every time you finish vacuuming, shake out the cloth and Micro filters.
2. Each week, rinse, dry and return the foam/filter diffuser to the bottom of the TrailBlazer below the motor.
3. After each shift, wipe the inside and outside of the vacuum with a household cleaning agent.

---

## PREVENTATIVE MAINTENANCE

---

**ATTENTION:** The following information is for use by qualified service personnel only and is to provide guidance for troubleshooting and maintenance.

**⚠ WARNING:** To reduce the risk of fire, electric shock or injury unplug unit from wall outlet when not in use and before servicing.

- UNPLUG the vacuum when working on the motor or any electrical part.
- CHECK the condition of all electrical cords before each use.
- Have a qualified service person at an authorized Nobles Service Dealer CHECK the carbon brushes on the motor every six months and replace any brush worn down to 1/2" in length.
- DO NOT lubricate the motor; it is equipped with sealed bearings.

## TROUBLESHOOTING

1. If the vacuum will not operate, check:
  - a. The power supply cord at the wall outlet.
  - b. The power supply cord at the vacuum.
  - c. That the switch is in the "on" position and functioning properly.
2. If the pigtail (18" power cord) is getting warm, check to see that the extension cord does not exceed a length of 50 feet at 16 gauge or 100 feet at 14 gauge. Longer cords will overheat and damage the vacuum.
3. If the exhaust that comes out of the bottom of the vacuum is warmer than usual, check and/or clean all four filters.
4. If the power switch fails, check the circuit breaker. If that is not the problem, see an authorized servicing dealer.
5. If loss of suction occurs:
  - a. Check that debris is not plugging the hose, wand, and/or floor tool.
  - b. Check and/or clean both micro and cloth filters.
  - c. Check that the hose cuffs are fitting tightly on the hose and are not cracked.
  - d. Check that the cap is properly attached to the body.

## FILTER MAINTENANCE

### TRAILBLAZER™ AND TRAILBLAZER™ LITE MODELS

**⚠ WARNING: To reduce the risk of fire, electric shock or injury unplug unit from wall outlet when not in use and before servicing.**

1. Check the Micro filter EACH and EVERY time you start and finish vacuuming. A clogged and dirty filter restricts airflow and results in reduced suction and overheating.
2. While vacuuming throughout a building, stop every two hours or as needed to shake out the Micro filter (Figure 21). Replace with new Micro filter when necessary.



FIG. 21

**NOTE:** Lift both Micro filter and cloth filter out at the same time to avoid ripping the Micro filter, especially if it is full.

3. Once a month (or more often if necessary) hand or machine wash the cloth filter and let it LINE DRY. (Do not put it in the dryer).
4. Once a month (or more often if necessary) clean the dome filter, located inside the vacuum underneath the Micro and cloth filters (Figure 22).

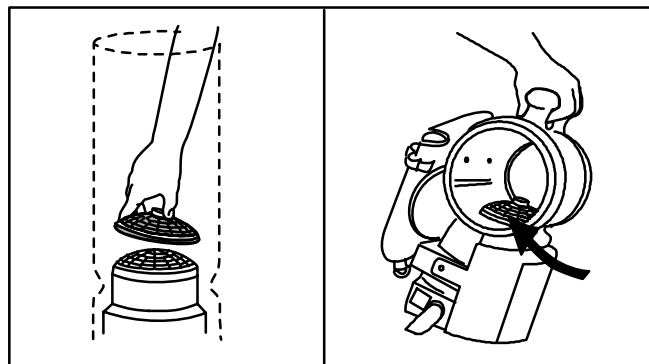

FIG. 22

- a. Pull the top piece of the dome filter off and remove the foam media (Figure 23). Shake it out, rinse it and let it air dry thoroughly.

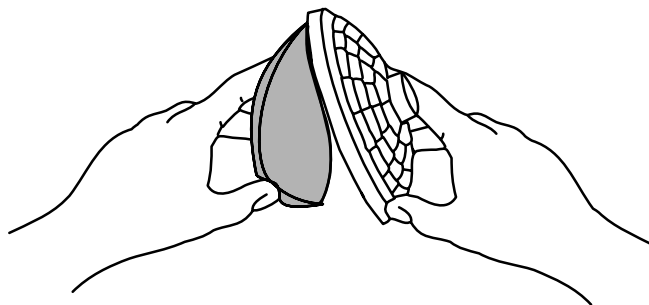

FIG. 23

## OPERATION

- b. Before the next use, return the foam media to its place. Replace with new foam media if necessary.
  - c. Firmly snap the top piece of the dome filter into place.
5. For the TrailBlazer and the TrailBlazer XL, each week rinse, air dry, and return the foam filter/diffuser at the bottom of the unit below the motor (Figure 24).



FIG. 24

6. For the TrailBlazer Lite, once a month (or as necessary) take off the shroud assembly by removing the two screws (Figure 25).

Rinse the foam attached to the inside of the shroud with warm, soapy water and let it drip dry. Reattach the shroud assembly before the next use.

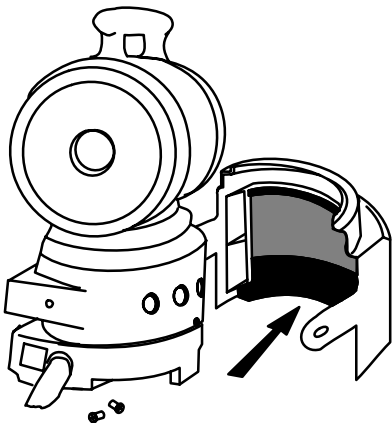

FIG. 25

### TRAILBLAZER™ XL MODEL

**⚠ WARNING:** To reduce the risk of fire, electric shock or injury unplug unit from wall outlet when not in use and before servicing.

1. Check the Micro filter EACH and EVERY time you start and finish vacuuming. A clogged and dirty filter restricts airflow and results in reduced suction and overheating.
2. While vacuuming stop every two hours or as needed to check the Micro filter. Replace with new Micro filter when necessary.

To install a Micro filter, slide the gasket of the Micro filter over the inlet on the inside of the top cap (Figure 26), then replace the cap, making sure that the latches catch correctly.

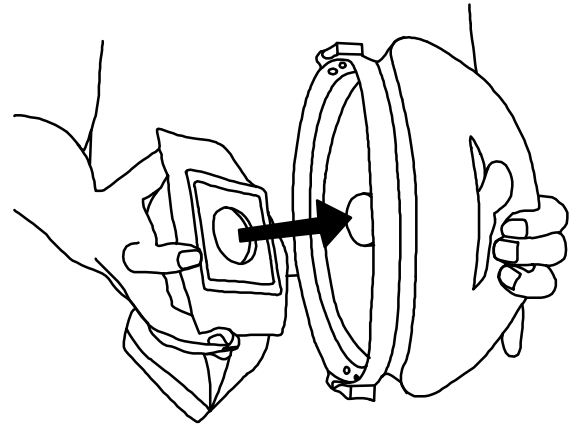
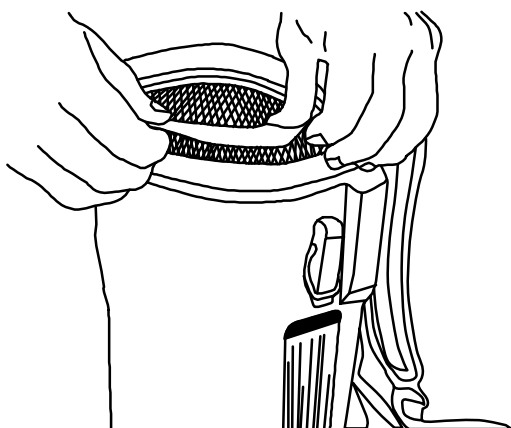

FIG. 26

**NOTE:** Lift both Micro filter and cloth filter out at the same time to avoid ripping the Micro filter, especially if it is full.

3. Once a month (or more often if necessary) hand or machine wash the cloth filter and let it LINE DRY. (Do not put it in the dryer).

When reinstalling the cloth filter, be sure the lip of the filter completely covers the rim of the vacuum (Figure 27).



**FIG. 27**

4. Once a month (or more often if necessary) clean the dome filter, located inside the vacuum underneath the Micro and cloth filters
  - a. Pull the top piece of the dome filter off and remove the foam media (Figure 28). Shake it out, rinse it and let it air dry thoroughly.

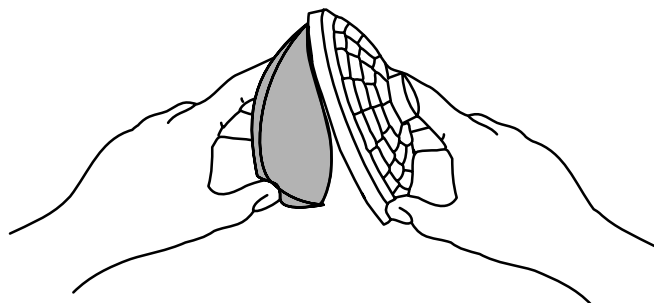

**FIG. 28**

- b. Before the next use, return the foam media to its place. Replace with new foam media if necessary.
- c. Firmly snap the top piece of the dome filter into place.

**NOTE:** If using a high filtration disc in place of the foam media, check it every 2–3 weeks. When the disc becomes discolored, replace it with a new disc. The life of the high filtration disc will depend greatly on the use and care of the Micro filter and cloth filter.

**RECOMMENDED STOCK ITEMS**

Refer to Parts List section for recommended stock items. Stock Items are clearly identified with a bullet preceding the parts description. See example below:

Ref.	Part No.	Description	Qty.
1	701103	ASM.,STANDPIPE	1
2	180613	●FLOAT, SHUTOFF	1
3	230187	NIPPLE	1
4	101714	●GASKET	1
5	210240	NUT, FLANGED	1

**SPECIFICATIONS**

MODEL	TrailBlazer™	TrailBlazer™ Lite	TrailBlazer™ XL
WEIGHT	4.1 Kg (9 lbs)	3.4 Kg (7.5 lbs)	5.2 Kg (11.5 lbs)
VACUUM MOTOR	120V, 1.25 HP, 2 stage	120V, 1.1 HP, 1 stage	120V, 1.8 HP, 1 stage
WATER LIFT	234 cm. (92 in)	160 cm. (63 in)	254cm. (100 in)
AIRFLOW	95 cfm	112 cfm	150 cfm
FILTRATION	99.79% @ .3 mic. with optional high filtration media disc	99.79% @ .3 mic. with optional high filtration media disc	99.79% @ .3 mic. with optional high filtration media disc
PRODUCTIVITY	688m <sup>2</sup> (7,400 sq.ft)/hr.	688m <sup>2</sup> (7,400 sq.ft)/hr.	688m <sup>2</sup> (7,400 sq.ft)/hr.
VACUUM BAG CAPACITY	6.6 L (6 qts)	6.6 L (6 qts)	10.7 L (9.8 qts)
POWER CORD LENGTH	15m (50 ft.)	15m (50 ft.)	15m (50 ft.)
VACUUM HOSE LENGTH	1.5m (5 ft.)	1.5m (5 ft.)	1.5m (5 ft.)
CONSTRUCTION	Polyethylene	Polyethylene	Polyethylene
SOUND LEVEL	68dB(A)	68dB(A)	70dB(A)

# PARTS LIST

## TRAILBLAZER™

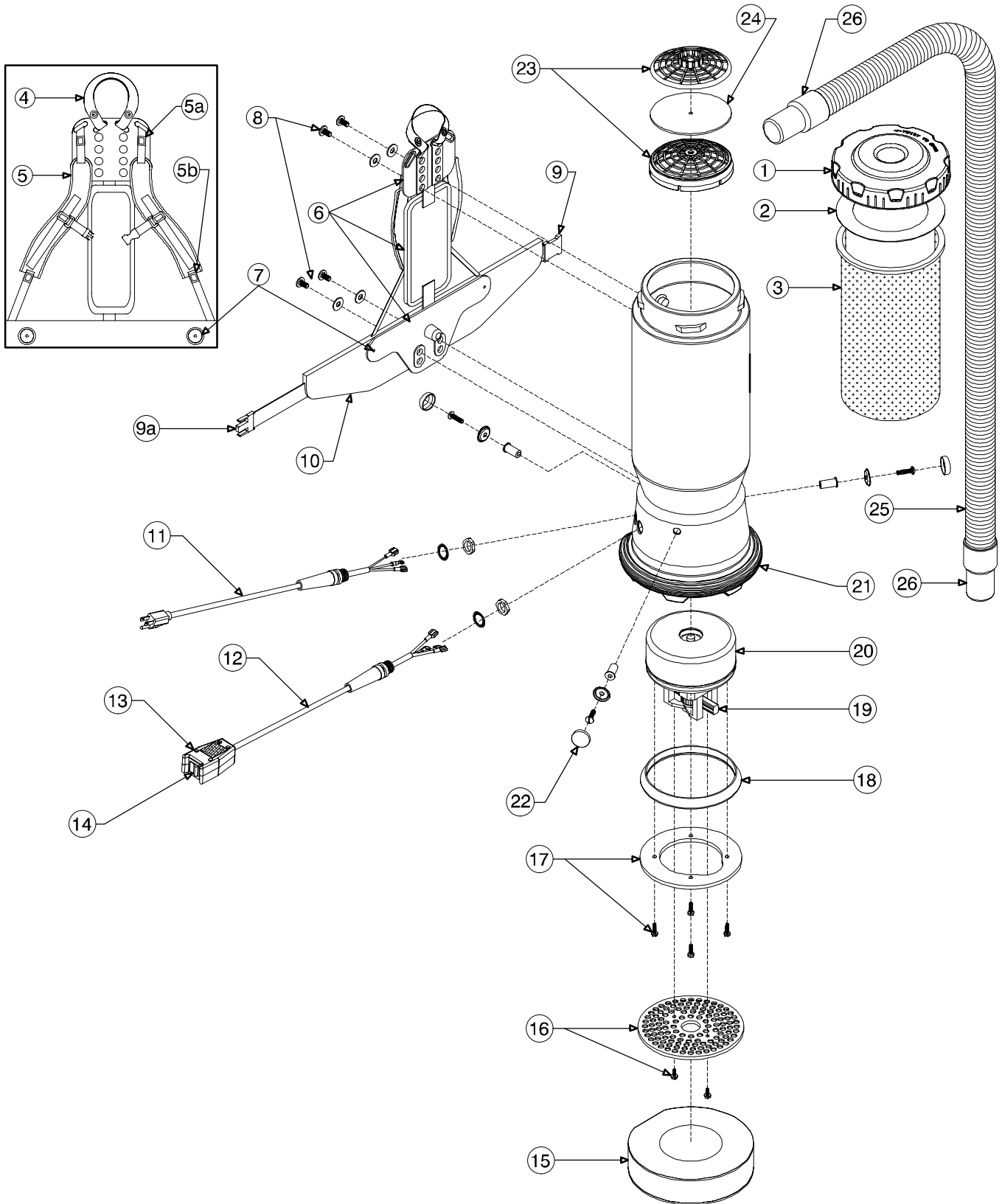

## TRAILBLAZER™

REF	PART #	DESCRIPTION	QTY.
1	612083	TWIST CAP (GREEN)	1
2	612084	●FILTER BAGS (10 PACK) TRAILBLAZER, TRAILBLAZER LITE	1
3	612299	●FILTER, 6QT. MICRO CLOTH	1
4	613054	HANDLE CARRY W/ RIVET AND WASHER SET	1
5	613055	STRAP, SHOULDER ASSEMBLY W/ STERNUM STRAP	1
		STRAP AND 2 BUCKLES	
5a	612327	STRAP, SHOULDER PLASTIC ADJUSTMENT BUCKLE TOP	1
5b	612328	STRAP, SHOULDER PLASTIC AD- JUSTMENT BUCKLE BOTTOM	1
6	613024	ASM., BACKPLATE TWO-PIECE W/ CENTER PAD	1
7	612330	KIT, NUT BARREL SET	1
8	612331	KIT, BACKPLATE BLACK SET	1
9	612332	KEEPER, WAIST BELT	1
9a	612333	LATCH, WAIST BELT	1
10	612334	BELT, WAIST	1
	613022	BACKPLATE, TWO-PIECE SYSTEM COMPLETE	1
11	612337	●ASM., POWER CORD (18" 16/3)	1
12	612340	●KIT, CORD SWITCH ASSEMBLY W/ BOX	1
	612338	CORD SWITCH W/ CRIMPS	1
13	612342	SWITCH BOX W/VELCRO® AND SCREWS	1
14	612316	SWITCH, DP ON/OFF	1
15	612343	SOUND MUFFLER	1

## ● RECOMMENDED STOCK ITEMS

REF	PART #	DESCRIPTION	QTY.
16	612344	AIR DIFFUSER, PLASTIC W/ SCREWS	1
17	612345	RING, MOTOR COMPRESSION W/ SCREWS	1
	612346	KIT, COMPRESSION RING	1
18	612347	TETRASEAL	1
19	612348	●CARBON BRUSH SET FOR 928W MOTOR	1
20	612368	●MOTOR, VAC W/ CRIMPS 928W(120V)	1
	612350	MOTOR VAC W/ CRIMPS 928W (220V)	1
	612351	MOTOR VAC W/ RECTIFIER AND CRIMPS 400HZ (AV)	1
	612352	RECTIFIER MOTOR (AVIATION- VAC)	1
	612353	KIT MOTOR GROUND CONNec- TION AND WIRE CLAMP	1
	612354	KIT, MOTOR CRIMP	1
21	612355	BOTTOM BUMPER	1
22	612356	MOTOR MOUNTING SYSTEM SET:	1
23	612357	DOMe FILTER W/ FOAM MEDIA	1
24	612358	FILTER, FOAM MEDIA FOR DOME FILTER	1
	612359	DISC, HIGH FILTRATION (OPTIONAL)	1
25	612087	HOSE VAC 1-1/2" STATIC- DISSIPATING BLACK W/ CUFFS	1
26	612323	CUFF HOSE SWIVEL REPLMT BLACK 1-1/2"	1
N/S	612718	ACCESSORY, 50' EXTENSION CORD ORANGE W/ CORD WRAP	1

TRAILBLAZER™ LITE

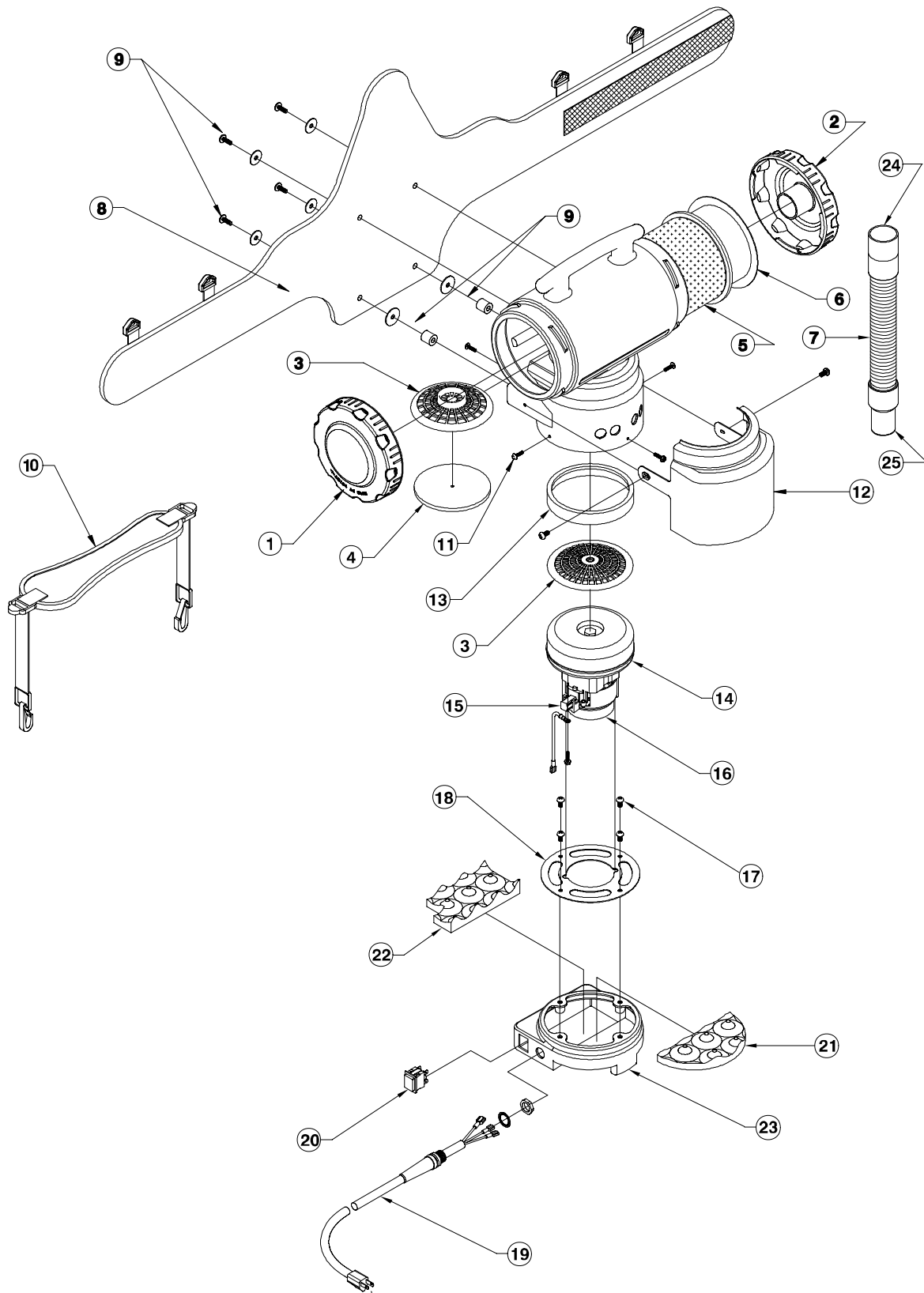



## TRAILBLAZER™ LITE

REF	PART #	DESCRIPTION	QTY.
1	612061	BLIND TWIST CAP ASSEMBLY (GREEN)	1
2	612068	TWIST CAP FOR 1½" CUFF (GREEN)	1
3	612296	DOME, FILTER W/FOAM MEDIA	1
4	612297	FILTER FOAM MEDIA FOR DOME FILTER	1
	612298	DISC HIGH FILTRATION (OPTIONAL)	1
5	612299	●FILTER 6QT. MICRO CLOTH	1
6	612084	●FILTER BAG (10 PACK) TRAILBLAZER, TRAILBLAZER LITE	1
7	612302	HOSE VAC 1–1/2" STRETCH W/ CUFFS 3:1	1
8	613057	WAIST BELT W/VELCRO®	1
	612306	RETROFIT SET: WAIST BELT AND MONOSTRAP	1
9	612304	WAIST BELT CONNECTION SET	1
10	612305	ASM., MONOSTRAP	1
11	612307	KIT, STEP CAP SCREW	1
12	612069	DEFLECTOR SHROUD ASSEMB	1
13	612309	SEAL, MOTOR	1

## ● RECOMMENDED STOCK ITEMS

REF	PART #	DESCRIPTION	QTY.
14	612310	●MOTOR/FAN 802 WATT (120 V)	1
612351	<del>612352</del>	MOTOR/FAN W/RECTIFIER AND CRIMPS	1
	612352	RECTIFIER, MOTOR (AVIATION-VAC)	1
15	613023	●CARBON BRUSH SET FOR 802W MOTOR	1
16	613056	KIT, FAN AND BRUSH COVER	1
17	612313	KIT, MOTOR MOUNT SCREW	1
18	612314	PLATE, DIRECTOR	1
19	612315	●CORD, 16/3 X 18" ASM W/ STRAIN-RELIEF	1
20	612316	●SWITCH, DP ON/OFF	1
21	612317	SOUND FOAM, FRONT BAFFLE	1
22	612318	SOUND FOAM, REAR BAFFLE	1
23	613058	STEP CAP (TEAL)	1
24	613059	KIT, RECEPTACLE REPLMT	1
25	612321	CUFF, HOSE FIXED REPLMT BLACK 1–1/2"	1
26	612323	CUFF, HOSE SWIVEL REPLMT BLACK 1–1/2"	1
N/S	612718	ACCESSORY, 50' EXTENSION CORD ORANGE W/ CORD WRAP	1

TRAILBLAZER™ XL

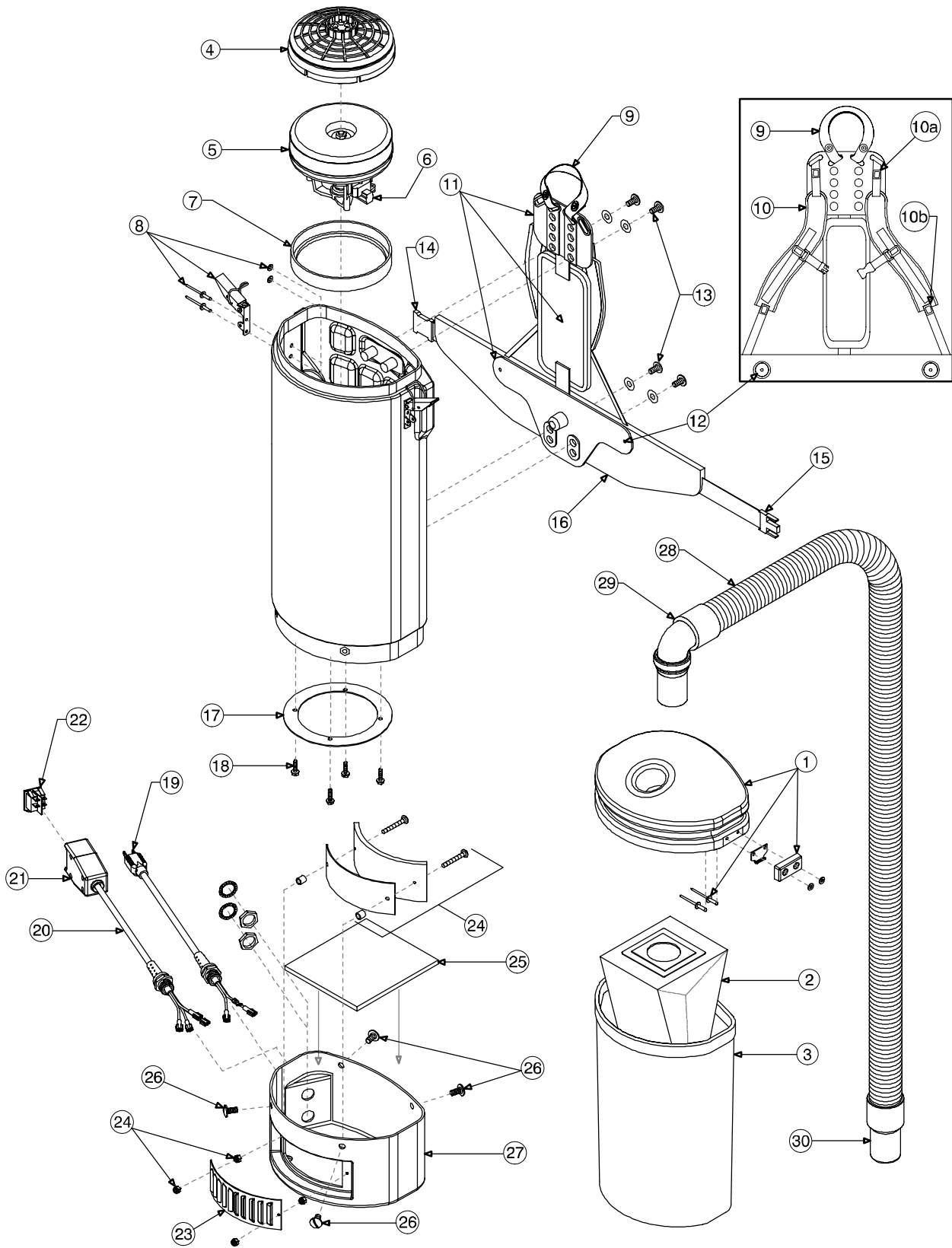

## TRAILBLAZER™ XL

REF	PART #	DESCRIPTION	QTY.
1	613060	ASM., LID	1
2	613020	●FILTER BAGS (10-PACK) INTER-CEPT MICRO, TRAILBLAZER XL	1
3	613021	●FILTER, MICRO CLOTH TRAILBLAZER XL	1
4	612357	DOME, FILTER W/ FOAM MEDIA	1
	612358	FOAM MEDIA FOR DOME FILTER	1
	612359	DISC, HIGH FILTRATION 2-PACK (OPTIONAL)	1
5	612370	●MOTOR/FAN W/CRIMPS, 1340 WATT 120V	1
6	612367	●CARBON BRUSH SET FOR 1340W MOTOR	1
7	612309	SEAL, MOTOR	1
8	613061	ASM., DRAW LATCH	1
9	613054	HANDLE, CARRY W/ RIVET AND WASHER SET	1
10	613055	STRAP SHOULDER ASSEMBLY W/ STERNUM STRAP	1
10a	612327	STRAP SHOULDER PLASTIC ADJUSTMENT BUCKLE TOP	1
10b	612328	STRAP SHOULDER PLASTIC ADJUSTMENT BUCKLE BOTTOM	1
11	613024	ASM., BACKPLATE TWO-PIECE W/ CENTER PAD	1
12	612330	KIT, NUT BARREL SET	1
13	612331	BACKPLATE (BLACK) CONNECTION SET	1
14	612332	KEEPER, WAIST BELT	1

## ● RECOMMENDED STOCK ITEMS

REF	PART #	DESCRIPTION	QTY.
15	612333	LATCH, WAIST BELT	1
16	612334	WAIST, BELT	1
	613022	BACKPLATE, TWO-PIECE SYSTEM COMPLETE	1
17	613062	MOTOR PLATE	1
18	612346	KIT, COMPRESSION RING	1
19	613025	●ASM., POWER CORD (18" 16/3)	1
20	612340	●KIT, CORD SWITCH ASSEMBLY W/ BOX	1
	612338	CORD SWITCH W/ CRIMPS	1
21	612342	SWITCH BOX W/VELCRO® AND SCREWS	1
22	612316	SWITCH, DP ON/OFF	1
23	613063	EXHAUST LOUVER	1
24	613064	ASM., SOUND/EXHAUST	1
25	613065	ACCOUSTIC INSULATOR, FELT LARGE	1
26	613066	KIT, BOTTOM CAP SCREW	1
27	613067	BOTTOM CAP (BLACK)	1
28	613068	HOSE, STATIC DISSIPATING W/ CUFFS	1
29	613069	REPLMT CUFF W/ SWIVEL ELBOW BLACK	1
30	612323	CUFF HOSE, SWIVEL REPLMT BLACK 1-1/2"	1
N/S	612718	ACCESSORY, 50' EXTENSION CORD ORANGE W/ CORD WRAP	1

**RESTAURANT VAC TOOL KIT**

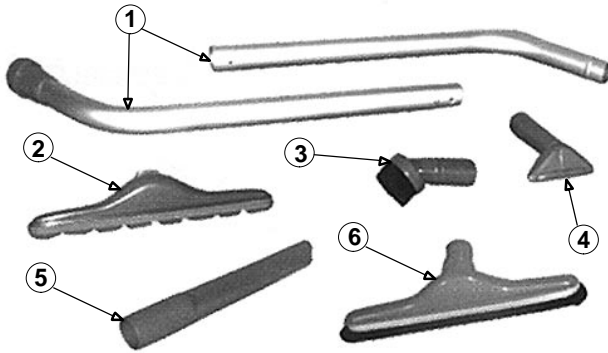

REF	PART #	DESCRIPTION	QTY.
▽	612575	KIT, VAC TOOL RESTAURANT 1-1/2"	1
▲ 1	612596	TOOL, WAND 1-1/2" 56" 2-PC 2-BEND ALUM W/ BUTTON LOCK	1
▲ 2	612600	TOOL, FLOOR 1-1/2" 14" W/ SCALLOPS	1
▲ 3	612582	TOOL, DUST BRUSH 1-1/2" 3" W/ REDUCER	1
▲ 4	612586	TOOL, UPHOLSTERY 1-1/2" 5"	1
▲ 5	612578	TOOL, CREVICE 1-1/2" 11"	1
▲ 6	612604	TOOL, FLOOR 1-1/2" 14" HARD-FLOOR W/ NYLON BRUSH	1

**COMMERCIAL VAC TOOL KIT**

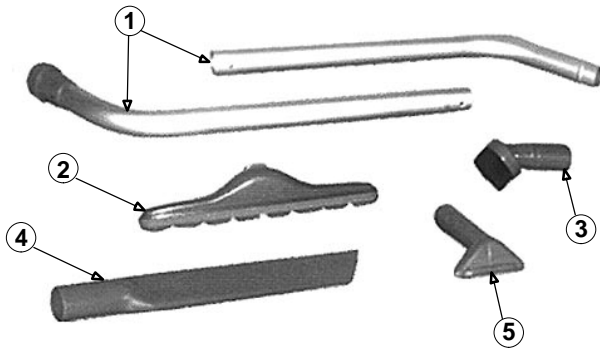

REF	PART #	DESCRIPTION	QTY.
▽	612576	KIT, VAC TOOL COMMERCIAL 1-1/2"	1
▲ 1	612596	TOOL, WAND 1-1/2" 56" 2-PC 2-BEND ALUM W/ BUTTON LOCK	1
▲ 2	612600	TOOL, FLOOR 1-1/2" 14" W/ SCALLOPS	1
▲ 3	612582	TOOL, DUST BRUSH 1-1/2" 3" W/ REDUCER	1
▲ 4	612579	TOOL, CREVICE 1-1/2" 17"	1
▲ 5	612586	TOOL, UPHOLSTERY 1-1/2" 5"	1

**E-Z GLIDE™ COMMERCIAL VAC TOOL KIT**

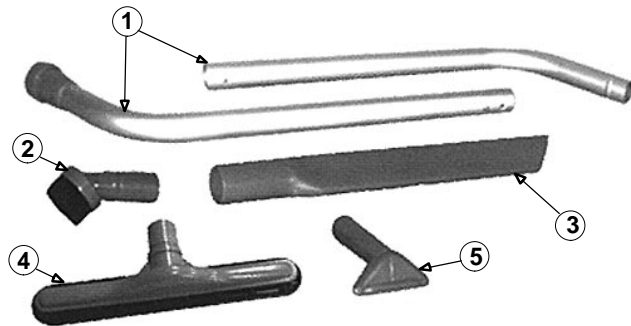

REF	PART #	DESCRIPTION	QTY.
▽	612283	KIT, VAC TOOL E-Z GLIDE COMMERCIAL 1-1/2"	1
▲ 1	612596	TOOL, WAND 1-1/2" 56" 2-PC 2-BEND ALUM W/ BUTTON LOCK	1
▲ 2	612582	TOOL, DUST BRUSH 1-1/2" 3" W/ REDUCER	1
▲ 3	612579	TOOL, CREVICE 1-1/2" 17"	1
▲ 4	612603	TOOL, FLOOR 1-1/2" 14" E-Z GLIDE W/ NYLON BRUSH	1
▲ 5	612586	TOOL, UPHOLSTERY 1-1/2" 5"	1

▽ ASSEMBLY

▲ INCLUDED IN ASSEMBLY

**TURBO FLOOR TOOL**

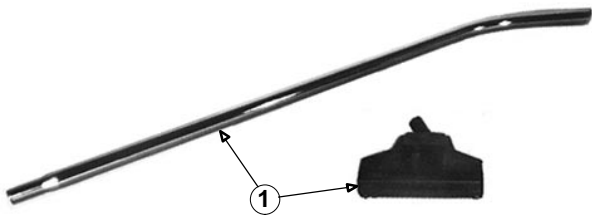

REF	PART #	DESCRIPTION	QTY.
1	612607	KIT, TOOL FLOOR 1-1/4" 11" TURBO BRUSH W/ WAND	1

**JETSWEEP™ FLOOR TOOL**



REF	PART #	DESCRIPTION	QTY.
1	612648	TOOL, FLOOR 1-1/2" 20" JET SWEEP W/ NYLON BRUSH	1



# U.S. AND CANADIAN NEW MACHINE WARRANTY POLICY

## Our Commitment to Customer Satisfaction

The warranty terms outlined below are in lieu of any other warranties, either expressed or implied, including any implied warranty of merchantability, fitness for a particular purpose or otherwise. Under no circumstances will seller be liable for any loss, damage, expense or consequential damages arising in connection with the use or inability to use, these products.

This warranty does not apply to damage or defect caused by accident, misuse, negligence, abuse, fire or to any Nobles product that has been serviced by anyone other than an authorized Nobles/Tennant service representative. Housings or parts that have become damaged as a result of improper use of the machine are excluded from this warranty. Refer to Owner's Manual for proper machine use and maintenance. Parts that are expected to wear from normal use and, therefore, are not covered under the parts warranty include: batteries (warranty pro-rated for one year); bearings; belts; brushes; filters; squeegees; switches; and tires.

This warranty commences on the date of purchase of the product by the original end user from an authorized Nobles sales representative, subject to proof of purchase. **A Machine Installation/Warranty Report form included with the Owner's Manual must be completed and returned immediately at the time of purchase.** If proof of purchase date is unavailable, the warranty begins 90 days after the sale of the product to an authorized Nobles dealer.

### 10-3-3 Warranty for Walk Behind Models

- Subject to the conditions outlined above, Nobles warrants the rotationally-molded polyethylene housings and parts on all of its machines to be free from defects in materials and workmanship, under normal use and service for ten (10) years to the original end user.
- Under this warranty, Nobles guarantees the performance of non-polyethylene parts and components on Nobles models to be free from defects for up to three (3) years or 2,500 hours of operation, whichever comes first, to the original end user. Parts replaced or repaired under this warranty are guaranteed for the remainder of the original warranty period.
- Labor charges are covered for three (3) full years from the date of purchase for Nobles products, provided an authorized Nobles/Tennant service provider is used for repair. Travel is covered for 90 days for battery models. No travel coverage is extended for cord electric models or the Typhoon16 Battery unit.

### 10-2-6 Warranty for Rider Models

- Subject to the conditions outlined above, Nobles warrants the rotationally-molded polyethylene housings and parts on its rider models to be free from defects in materials and workmanship under normal use and service for ten (10) years to the original end user.
- Under this warranty, we guarantee the performance of non-polyethylene parts and components on rider models to be free from defects for up to two (2) years or 1,000 hours of operation, whichever comes first, to the original end user. Parts replaced or repaired under this warranty are guaranteed for the remainder of the original warranty period.
- Travel and labor charges are covered for six (6) months from date of installation. Nobles will, at its option, provide travel (maximum of 3 hours) and labor for repair, or pay for outside repair service in accordance with Nobles Company's flat rate schedule for certain warranty repairs.

**Product Exceptions and Exclusions:** A one year warranty is extended to the original end user against manufacturing defects and workmanship on non-wear components for these machines: Anserportable spotter; TV1200, Pathmaker, and Viper vacuums; the Tidy-Vac dry canister vacuum; the Scout 27 and 28 sweepers; the Cyclone dryer; and the TrailBlazer Series. Battery chargers and all accessories are warranted for one year.

Date Purchased:	_____
Model Number:	_____
Serial Number:	_____

Please make sure to record this information. This information will be necessary for future warranty claims.

Nobles reserves the right to change its warranty policy without notice.